

TYPICAL APPLICATIONS

NO. 1

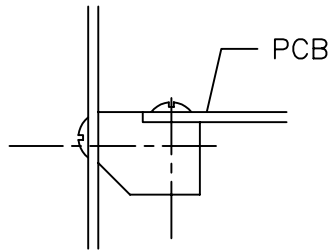

NO. 2

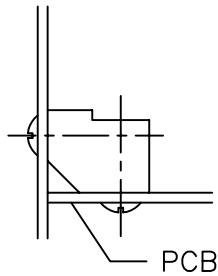

NO. 3

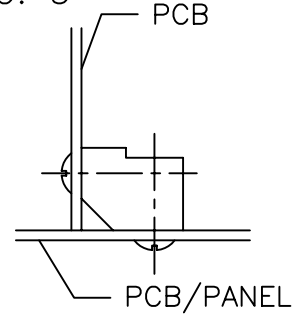

NO. 4

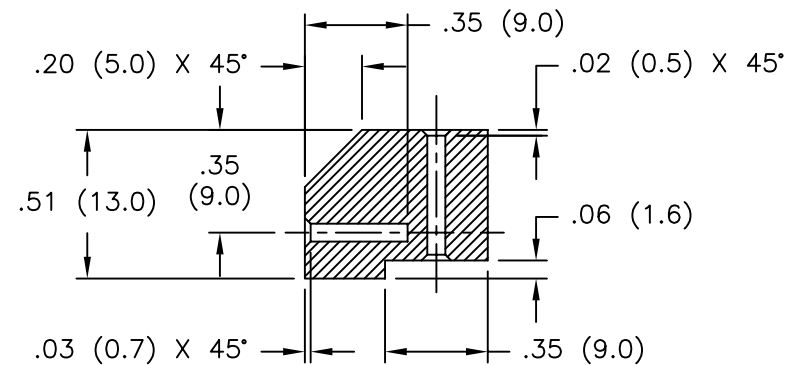
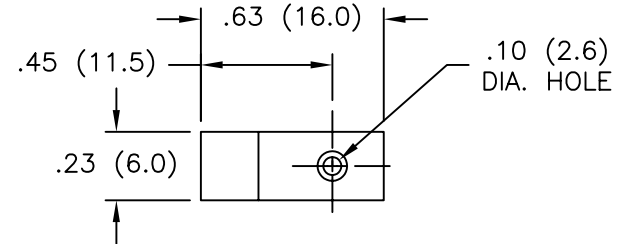
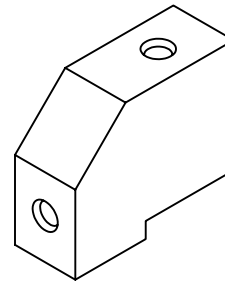
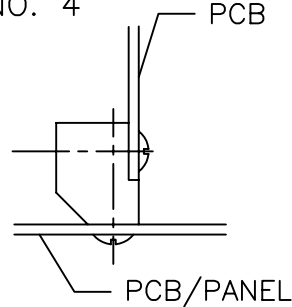

NOTES:

1. MATERIAL: NYLON 6/6 (RMS-01).
COLOR: NATURAL
2. MOUNTING SCREW: NO. 4 (TYPE B) (M3) SELF TAPPING SCREW
3. FLAME RETARDANT NYLON (RMS-19).
AVAILABLE BY SPECIAL ORDER

B	SEE ECN #870 FOR CHANGES	SM 10.21.04
A	UPDATED PRINT AND CHANGED FILE NO.	SM 02.11.02
REV	DESCRIPTION	ENGR DATE

TITLE: MOUNTING BLOCK					DWG IN IN (MM)	
TOLERANCES UNLESS NOTED .XX=±.010 .XXX=±.005 FRAC=1/64 ANG=1°	FILE # PCB-MB	DWN: P.B.	APP:	FINAL		
	MAT'L: SEE NOTES	DT: 03-01-94	DT:	PART #	PRINT TYPE	
	RE: RICHCO, INC.	RICHCO INC. PO BOX 804238, CHICAGO, 60680 (773) 539-4060		PCB-MB-01	CA	